

# mobility<sup>+</sup>

enteral feeding system<sup>®</sup>

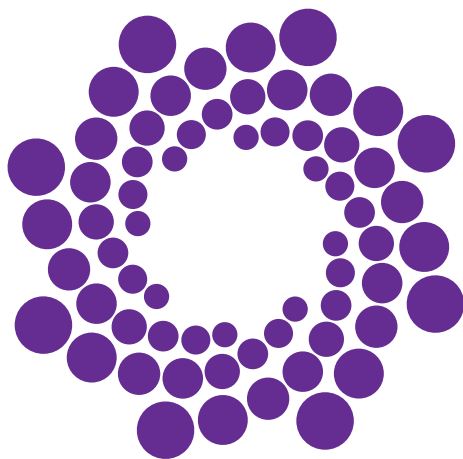

## Instructions For Use



Manufactured in the E.U. for:  
Rockfield Medical Devices Ltd.,  
iHub GMIT (ATU), Dublin Road,  
Galway,  
Ireland H91DCH9.



[www.rockfieldmd.com](http://www.rockfieldmd.com)

Mobility+<sup>®</sup> is a trademark of Rockfield Medical Devices. ENFit<sup>®</sup> is a trademark of GEDSA, used with permission. ©2023 Rockfield Medical Devices, Ltd.

2023-10-27 DWC124

# Table of Contents

- Mobility+® System Contents . . . . . 1**
  
- Safety & Warning . . . . . 2**
  - Indications for Use . . . . . 2
  - Contraindications . . . . . 2
  - Precautions . . . . . 2
  
- How to Wear Mobility+® . . . . . 3**
  - Guidelines . . . . . 3
  
- Mobility+® Setup . . . . . 4**
  - Controlling the Flow of Fluid . . . . . 4
  - Closing and Opening the Clamps . . . . . 4
  - Giving Set Lengths and Clamp Colours . . . . . 4
  - Cross Spike . . . . . 4
  
- Filling Method A - Decanted Feed . . . . . 5**
  
- Filling Method B - Hanging Bag . . . . . 8**
  
- Flushing . . . . . 11**
  
- Symbol Glossary . . . . . 13**

For communications regarding the device, you can contact us by scanning the QR code, calling the number below or visiting:  
<https://rockfieldmd.com/communications/>

 +1-332-236-8797



# Mobility+® System Contents



1x Enteral Feeding Pouch

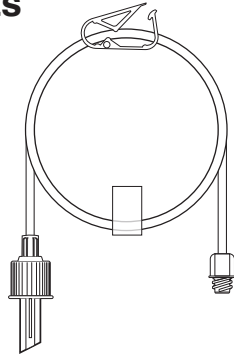

1x ENFit® Giving Set

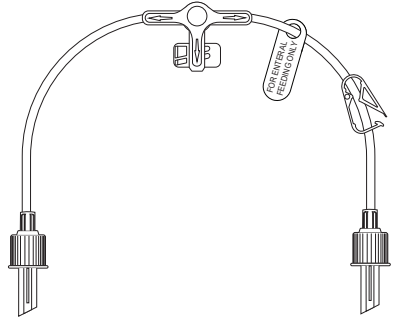

1x ENFit® Filling Set

Syringe required (ENFit® 60 ml): not supplied

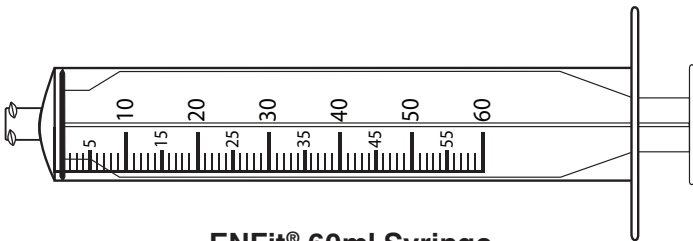

ENFit® 60ml Syringe

# Safety & Warning

**WARNING: For enteral feeding use only. Not for IV use.**

**This device incorporates ENFit® connectors which are designed to reduce the likelihood of tubing misconnections. However, the potential to misconnect this device with connectors of other healthcare applications still exists.**

## Indications for Use

Mobility+® is intended to deliver liquid nutrition formula to an enteral access device (feeding tube) in users aged 2 years and over.

## Contraindications

- Not for NG (Nasogastric) feeding or TPN (total parenteral nutrition).
- Not for drug/medication delivery.

## Precautions

- To avoid snagging of the Giving Set tubing, loosely coil any excess tubing and keep it secure.
- Tubing sets can be a strangulation hazard. Do not put the Giving Set tubing around your neck. Avoid leaving tubing sets where infants or children can become entangled. If tubing sets become entangled around the neck, strangulation and death can occur.
- Take care not to overtighten ENFit connectors.
- To be used under supervision of adult caregiver or healthcare professional.
- Consult with your healthcare professional before engaging in strenuous physical activity while feeding.
- Single patient use only.
- Follow recommended guidelines on hang time of feeds.
- Do not put heavy weight on feeding pouch when filled.
- Do not squeeze feeding pouch during use as it may affect desired flow rate.
- Small parts can be a potential choking hazard. Keep out of reach of children.
- Not for blenderized feed.
- Min fill is 250 ml (8.5 oz) and max fill is 500 ml (16.9 oz). Approximately 25 ml (0.85 oz) of residual feed may remain in the system after use.
- Confirm that any ENFit® transition connectors are connected to an enteral port and not an IV set.
- Take care not to kink the tubing.
- Do not use if package is open or damaged.
- Use between 15 - 35 °C (59 - 95 °F).
- Spout of feeding pouch must be within ±15cm (±6 inches) height of stoma.
- Do not put the feeding pouch near sharp objects.
- Prepare feed as per manufacturer's instructions.
- Store in cool, dry conditions.

**Discard 24 hours after first use. Dispose of all parts of the Mobility+® system with household waste.**



# How to Wear Mobility+®

Mobility+® is wearable during use. You can wear it in clothing, on clothing or in a bag of your choice.

## Guidelines

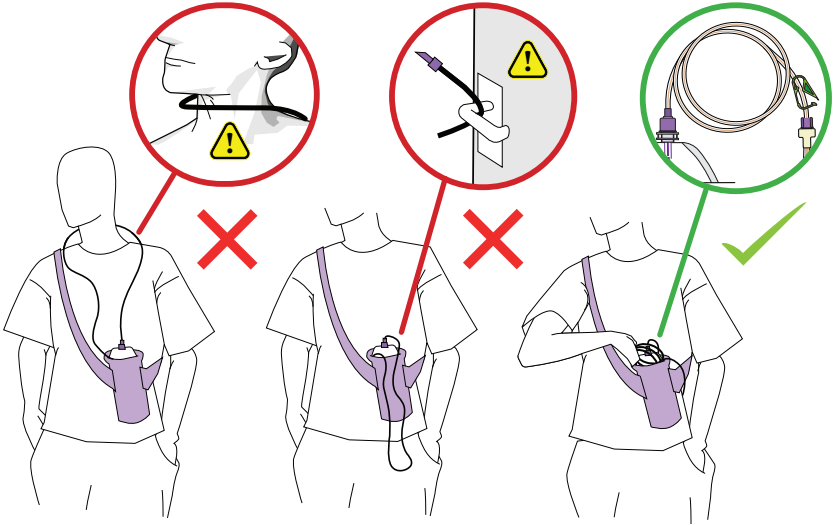

**Do not put tubing around your neck.**

**Uncoiled tubing can be a snag hazard.**

**Excess Giving Set tubing should be coiled and secured during use.**

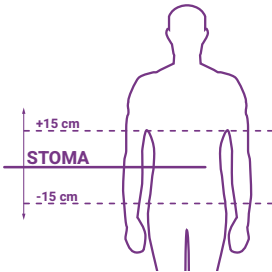

**When feeding, it is recommended that the feeding pouch spout is positioned within 15 cm above or below the stoma position**

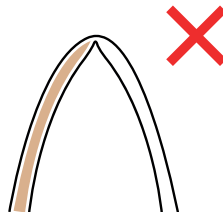

**Do not kink the tubing**

# Mobility+® Setup

## Controlling the Flow of Fluid

with the 3-Way Valve on ENFit® Filling Set

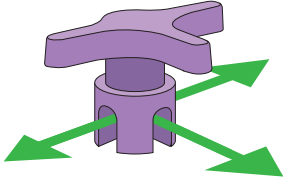

3-Way Valve

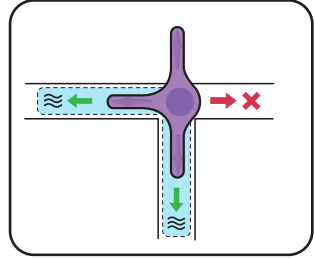
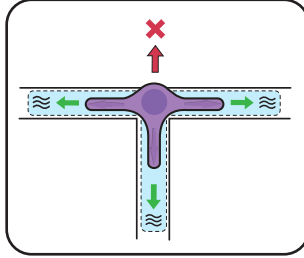

## Closing and Opening the Clamps

on the tubing sets

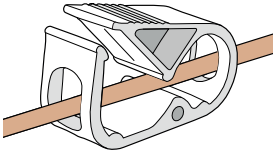

Clamp

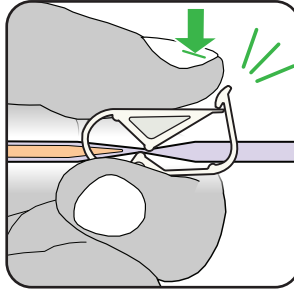

Close

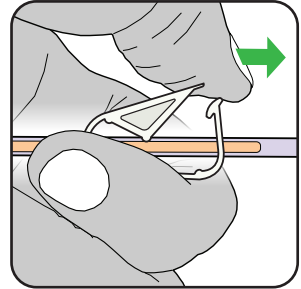

Open

## Giving Set Lengths and Clamp Colours

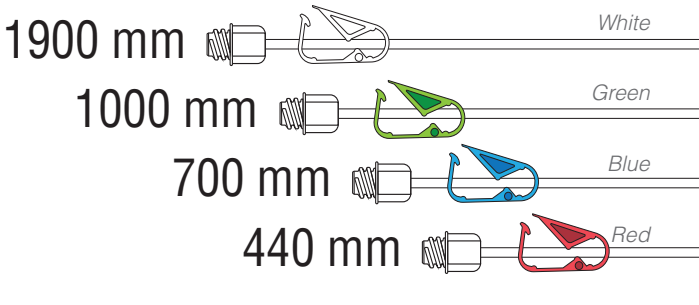

## Cross Spike

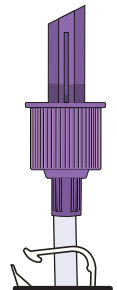

# Filling Method A - Decanted Feed

Filling from feed decanted into a container

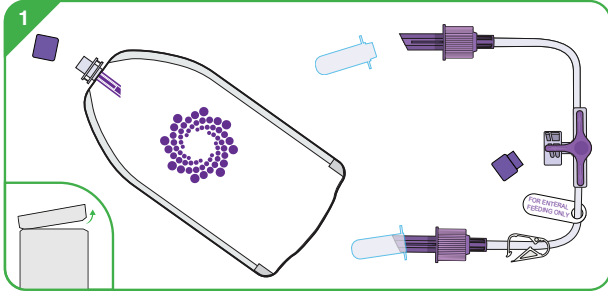

Tear open the sealed package and remove the protective caps on the Feeding Pouch and **Filling Set**.

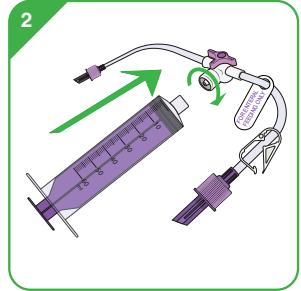

Connect the ENFit® 60ml Syringe to the 3-Way Valve on the **Filling Set**.

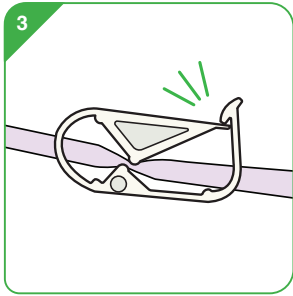

Close the clamp of the **Filling Set**.

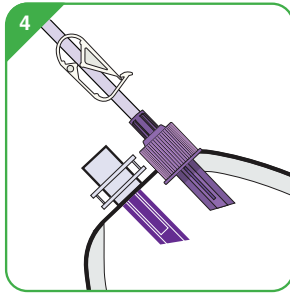

Align the Cross Spike with the graphic on the Feeding Pouch.

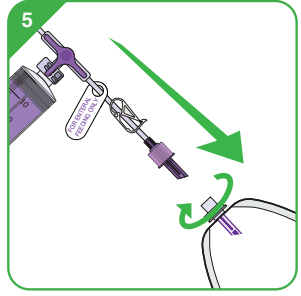

Push in the Cross Spike and screw down the cap until securely fastened.

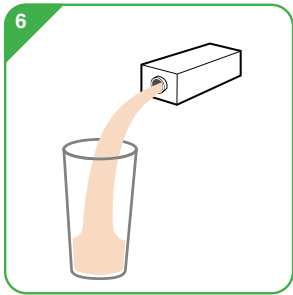

Pour feed into the container.

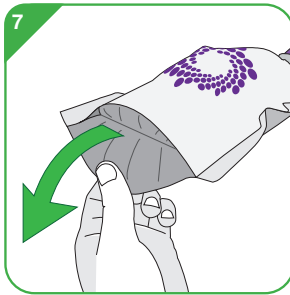

Gently widen the bottom of the Feeding Pouch.

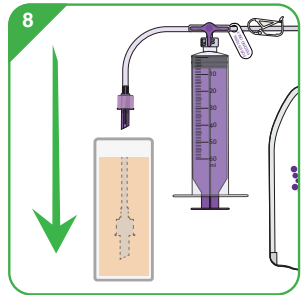

Place the unconnected end of the **Filling Set** into the container of feed.

Perform Steps 9 - 12 until the desired volume or max 500ml (16.9 oz) has been filled.

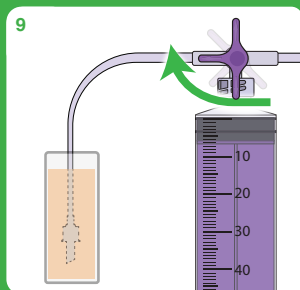

Rotate the 3-Way Valve on the **Filling** Set towards the container.

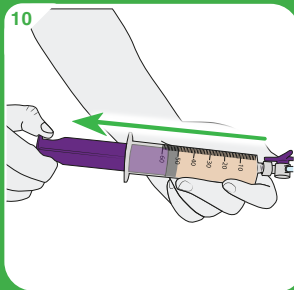

Pull the plunger of the Syringe to transfer 50ml of feed from the container into the Syringe.

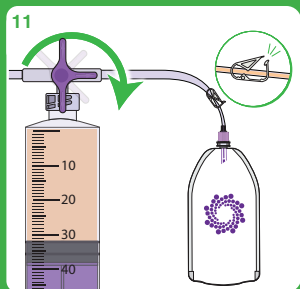

Rotate the 3-Way Valve towards the Feeding Pouch. Open the Clamp.

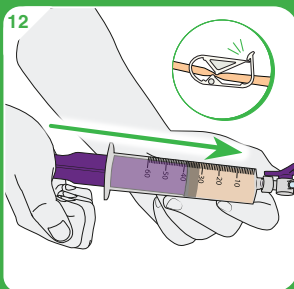

Push the feed into the Feeding Pouch. Then, close the clamp to prevent air or feed pushing back.



*Note: Users may experience a need for increased effort as they fill the Feeding Pouch using the Syringe.*

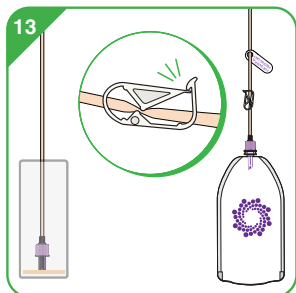

When the Feeding Pouch has the desired volume, close the clamp.

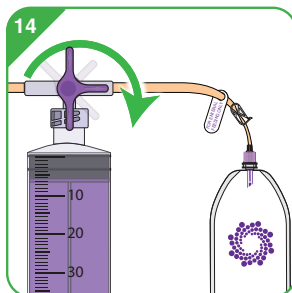

Stand the Feeding Pouch upright. Ensure the 3-Way Valve is rotated towards the Feeding Pouch.



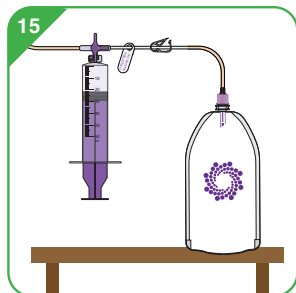

Hold the syringe plunger steady and open the clamp.

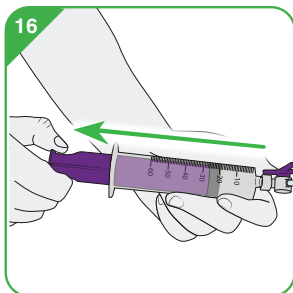

Slowly pull the plunger of the Syringe, until all the air has been removed from the Feeding Pouch. Close the clamp.

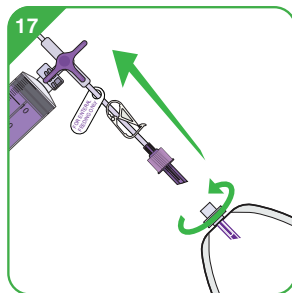

Disconnect the **Filling Set** from the Feeding Pouch.

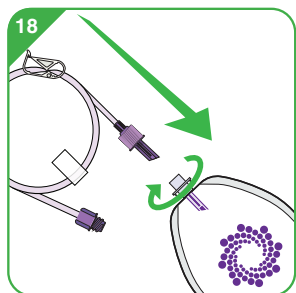

Remove the two protective caps on the **Giving Set**. Close the clamp. Connect the **Giving Set** to the Feeding Pouch

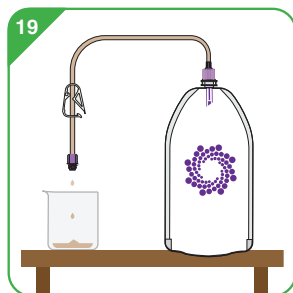

Open the clamp until feed begins to drip from the **Giving Set** into the container, then close the clamp.

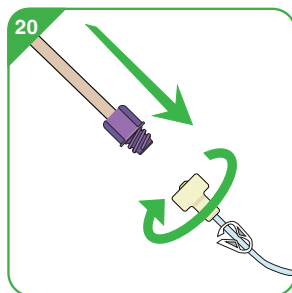

To feed, connect the **Giving Set** to your **feeding tube**, ensuring you don't overtighten. Open the clamp on the **Giving Set**.\*

\* If using an **extension set**, ensure that the connection between the **Giving Set** and **extension set** is snug and not too tight. Open the clamp of the **extension set**. Then, open the clamp of the **Giving Set** to prime the **extension set**.

## Disconnecting

On completion of the feeding session, disconnect the **Giving Set** from the **extension set** or **feeding tube**, then disconnect the **Giving Set** from the Feeding Pouch.

Flush all components after each use (see **FLUSHING** page 11).

# Filling Method B - Hanging Bag

Filling from a ready to hang feed bag

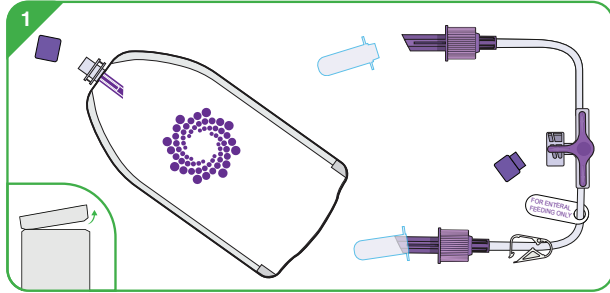

Tear open the sealed package and remove the protective caps on the Feeding Pouch and **Filling Set**.

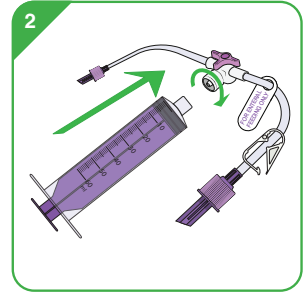

Connect the ENFit® 60ml Syringe to the 3-Way Valve on the **Filling Set**.

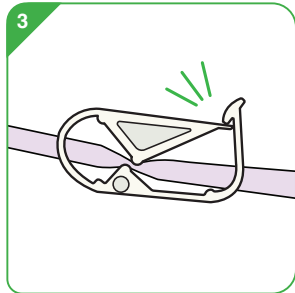

Close the clamp on the **Filling Set**.

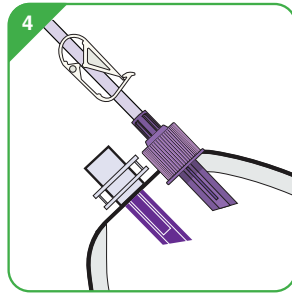

Align the Cross Spike with the graphic on the Feeding Pouch

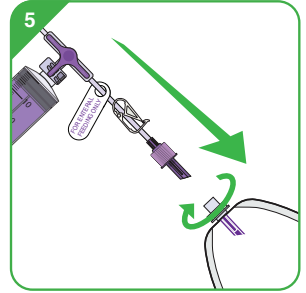

Push in the Cross Spike and screw down the cap until securely fastened.

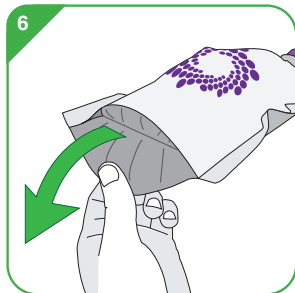

Gently widen the bottom of the Feeding Pouch.

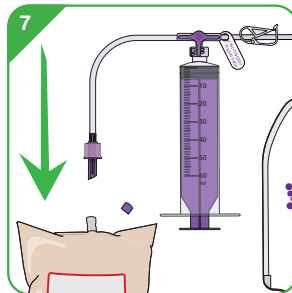

Remove the cap from the feed bag. Connect the other end of the **Filling Set** into the feed bag.

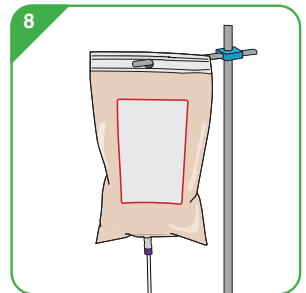

Hang up the feed bag.

Perform Steps 9 - 12 until the desired volume or max 500ml (16.9 oz) has been filled.

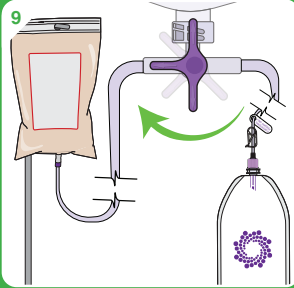

Rotate the 3-Way Valve on the **Filling Set** towards the hanging feed bag.

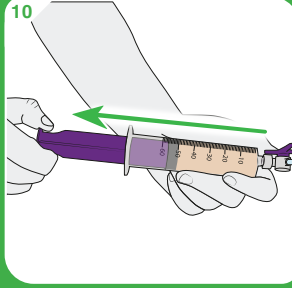

Pull the plunger of the Syringe to transfer 50ml of feed from the container into the Syringe.

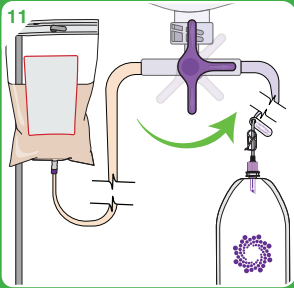

Rotate the 3-Way Valve towards the Feeding Pouch. Open the clamp.

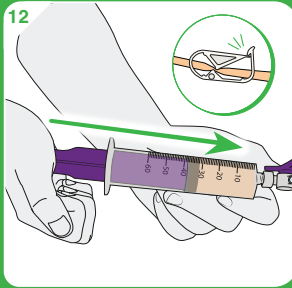

Push the feed into the Feeding Pouch. Then, close the clamp to prevent feed or air pushing back.



*Note: Users may experience a need for increased effort as they fill the Feeding Pouch using the Syringe.*

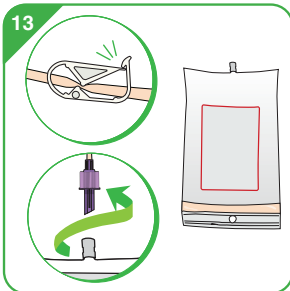

When the Feeding Pouch has the desired volume, close the clamp. Unhang the feed bag. Remove the **Filling Set** from the feed bag.

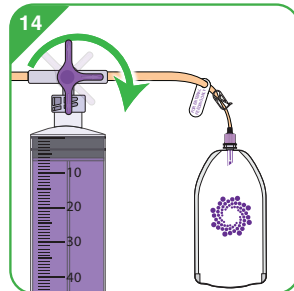

Stand the Feeding Pouch upright. Ensure the 3-Way Valve is rotated towards the Feeding Pouch.

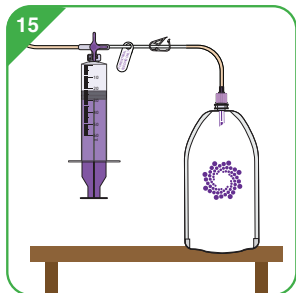

Hold the syringe plunger steady and open the clamp.

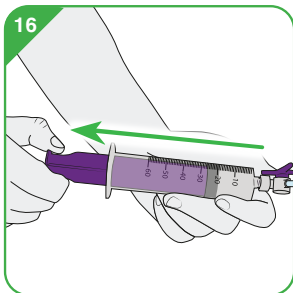

Slowly pull the plunger of the Syringe, until all the air has been removed from the Feeding Pouch. Close the clamp.

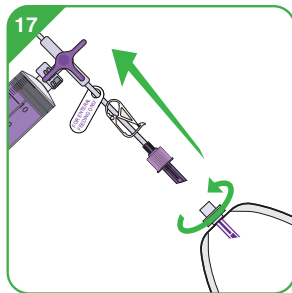

Disconnect the **Filling Set** from the Feeding Pouch.

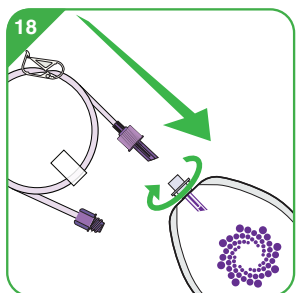

Remove the two protective caps on the **Giving Set**. Connect the **Giving Set** to the Feeding Pouch

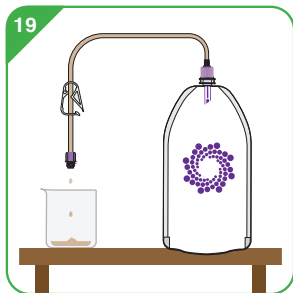

Open the clamp until feed begins to drip from the **Giving Set** into a container, then close the clamp.

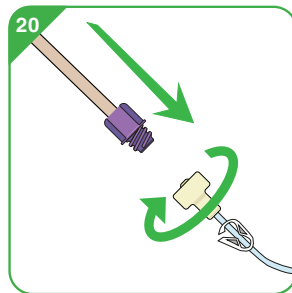

To feed, connect the **Giving Set** to your **feeding tube**, ensuring you don't overtighten. Open the clamp on the **Giving Set**.\*

\* If using an **extension set**, ensure that the connection between the **Giving Set** and **extension set** is snug and not too tight. Open the clamp of the **extension set**. Then, open the clamp of the **Giving Set** to prime the **extension set**.

## Disconnecting

On completion of the feeding session, disconnect the **Giving Set** from the **extension set** or **feeding tube**, then disconnect the **Giving Set** from the Feeding Pouch.

**Flush all components after each use (see FLUSHING page 11).**

# Flushing

Two containers are needed, one for feed waste, and the other for clean water.

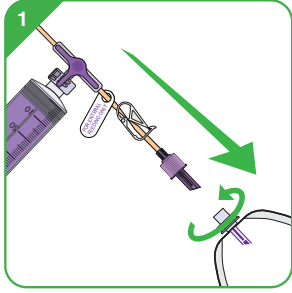

Close the clamp on the **Filling Set**. Connect the **Filling Set** to the Feeding Pouch.

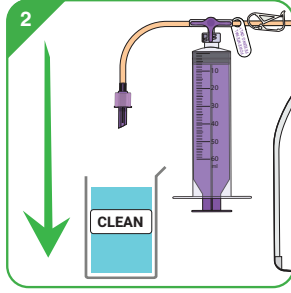

Place the unconnected end of the **Filling Set** into the clean water.

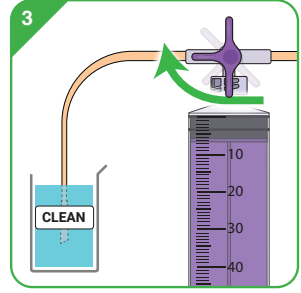

Rotate the 3-way-valve towards the clean water.

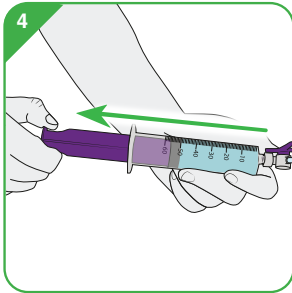

Pull the plunger of the Syringe to fill the Syringe with 50ml of water.

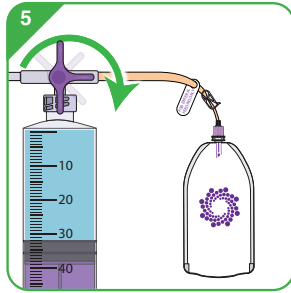

Rotate the 3-way-valve towards the Feeding Pouch.

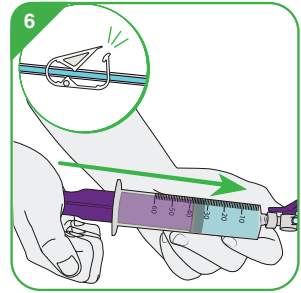

Open the clamp and push the water into the Feeding Pouch. Close the clamp.

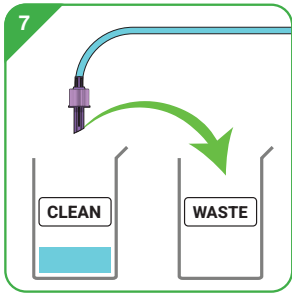

Move the **Filling Set** from the water container to the waste container.

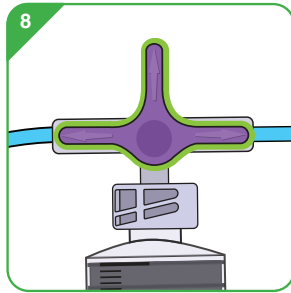

Turn the 3-way-valve so that it matches the position shown.

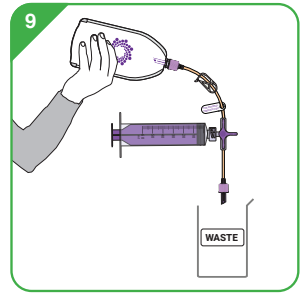

Hold the Feeding Pouch at a height above the container.

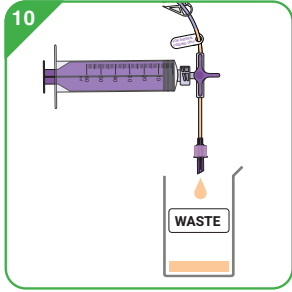

Open the clamp to flush water out through the **Filling Set** into the waste container.

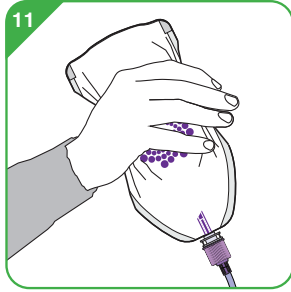

Squeeze the Feeding Pouch to aid flushing. Once all the water is flushed out through the **Filling Set**, close the clamp.



Repeat steps 2 to 11 one more time.

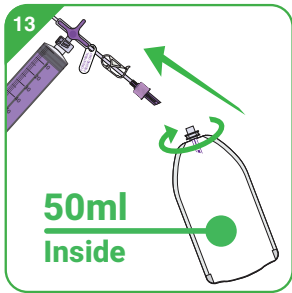

Fill the Feeding Pouch with 50ml of water by repeating steps 2 to 6. Close the clamp. Remove **Filling Set**.

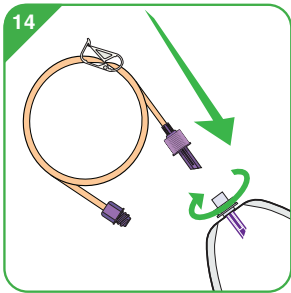

Close the clamp on the **Giving Set** and connect the **Giving Set** to the Feeding Pouch.

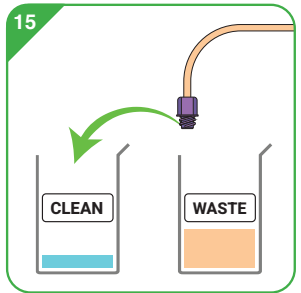

Place the end of the **Giving Set** into the waste container.

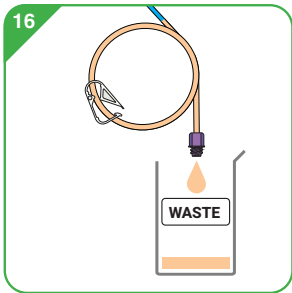

Open the clamp to flush water out through the **Giving Set** into the container.

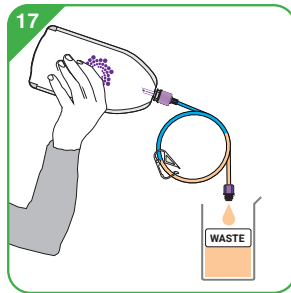



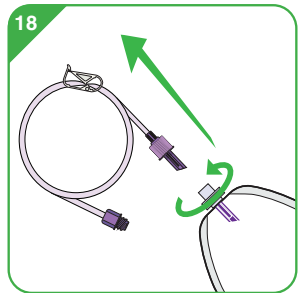









Hold the Feeding Pouch at a height and squeeze until all the water is flushed through the **Giving Set**.



Close the clamp and disconnect the **Giving Set** from the Feeding Pouch.

# Symbol Glossary

<p><b>Manufacturer.</b> Indicates the medical device manufacturer. Ref. 5.1.1 in ISO 15223-1:2021</p>	
<p><b>Use-by date.</b> Indicates the date after which the medical device is not to be used. Ref. 5.1.4 in ISO 15223-1:2021</p>	
<p><b>Batch code.</b> Indicates the manufacturer's batch code so that the batch or lot can be identified. Ref. 5.1.5 in ISO 15223-1:2021</p>	
<p><b>Catalogue number.</b> Indicates the manufacturer's catalogue number so that the medical device can be identified. Ref. 5.1.6 in ISO 15223-1:2021</p>	
<p><b>Non sterile.</b> Indicates a medical device that has not been subjected to a sterilization process. Ref. 5.2.7 in ISO 15223-1:2021</p>	
<p><b>Do not use if package is damaged.</b> Indicates a medical device that should not be used if the package has been damaged or opened. Ref. 5.2.8 in ISO 15223-1:2021</p>	
<p><b>Keep away from sunlight</b> Indicates a medical device that needs protection from light sources. Ref. 5.3.2 in ISO 15223-1:2021</p>	
<p><b>Keep Dry</b> Indicates a medical device that needs to be protected from moisture. Ref. 5.3.4 in ISO 15223-1:2021</p>	
<p><b>Consult instructions for use.</b> Indicates the need for the user to consult the instruction for use. Ref. 5.4.3 in ISO 15223-1:2021</p>	
<p><b>Not made from natural latex</b> Indicates no presence of natural rubber or dry natural rubber latex as a material of construction within the medical device or the packaging of a medical device. Ref. 5.4.5 in ISO 15223-1:2021</p>	
<p><b>DEHP Free</b> Indicates no presence of di-2-ethylhexyl phthalate (DEHP) as a material of construction within the medical device or the packaging of a medical device. Ref. 4.2 in EN 15986:2011</p>	
<p><b>Caution:</b> Federal Law restricts this device to sale by or on the order of a licensed healthcare practitioner. Ref. 21 CFR 801.109(b)(1)</p>	
<p><b>24 Hour Use</b> Indicates device should be discarded 24 hours after first use.</p>	

For communications regarding the device, you can contact us by scanning the QR code, calling the number below or visiting:  
<https://rockfieldmd.com/communications/>

 +1-332-236-8797



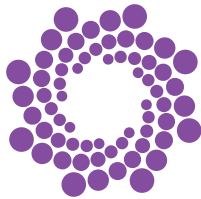

(11)231027(21)DWC124

Mobility+® is a trademark of Rockfield Medical Devices. ENFit® is a trademark of GEDSA, used with permission. ©2023 Rockfield Medical Devices, Ltd.

2023-10-27 DWC124